

**What you need to know:**

- Know the primary sources of materials for producing papers & boards
- Be able to identify a range of papers & boards.
- Understand their properties and the functions they provide and how they are used?

Papers and boards are used for a variety of purposes from writing, drawing, packaging and model making. They are made from cellulose fibres found in wood or grasses which are all renewable.

Paper & boards can be plain, textured and can be laminated with other materials like plastic to make them waterproof.

Paper and board is measured in sizes from A0 to A6 and in weight by grams per square metres (gsm). Boards (card or cardboard) are always greater than 200gsm

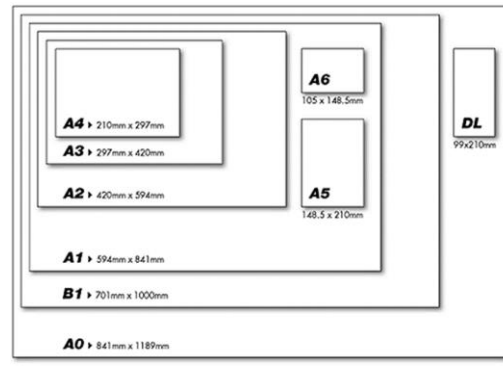

**Processing paper & card:**

This involves turning raw materials into usable products. In the case of paper, the raw material is usually **wood**.

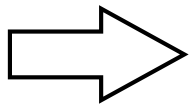

In the first stage of paper manufacture, the wood is mashed up to make **wood pulp**.

This is done in one of two ways.

**By machine**

The wood is physically ground up. Paper made from machined pulp is weaker and turns yellow over time. It is used for newspapers.

**By chemicals**

Wood chips are mixed with chemicals that dissolve the bonds between the fibres. Chemical pulp is used for writing and printing paper.

The wood pulp is then bleached to make it white, and fed into a **Fourdrinier** machine. This machine makes the pulp into paper.

1. Firstly, dyes and other chemicals are added to the pulp.

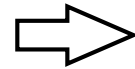

2. The pulp is then spread onto a moving wire mesh conveyor belt.

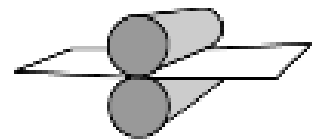

The second rollers are heated to dry the paper.

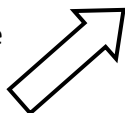

4. The calendar rollers then smooth the paper and determine the thickness.



The first rollers squeeze out the water.

**Types of papers**

Papera	Example	Properties	Uses
<b>Bleed proof</b>		A smooth paper often used with water and marker pens which prevents bleed (e.g. when ink runs through the paper).	Presentation drawings
<b>Cartridge paper</b>		Good quality white paper with a slight texture.	Can be used for paints, markers and drawings
<b>Grid</b>		Paper printed with grids as guideline for drawing (e.g. isometric).	Quick model 3D drawings
<b>Layout</b>		Strong and lightweight	Initial sketching and tracing
<b>Tracing</b>		Fluted plastic – light, strong weather resistant material	Tracing copies of drawings

**Selecting Papers & Boards**

The type of paper & board used to make a product depends on the following factors:

- Aesthetics
- Size of product
- Where and how the product will be used?
- Stability
- Cost
- Size
- Weight
- Finish required
- Lifetime of the product
- Desired properties.

**Types of boards**

Boards	Example	Properties	Uses
<b>Corrugated card</b>		Strong lightweight material Made from two or more layers and has a fluted middle	Packaging such as pizza boxes, large boxes that are used to protect heavy items
<b>Duplex board</b>		Thin board that often has one side printed. This board can also be coated with wax so it can be used with food and drink	Packaging
<b>Foil lined board</b>		Board covered with one side of aluminum foil making it a good insulator	Packaging such a takeaway and ready meal packaging.
<b>Foam core board</b>		Two pieces of board with a foam core to increase the thickness but retain its light weight property.	Model making such as architectural models.
<b>Solid white board</b>		High quality cardboard, smooth on both sides which makes it good for printing.	Book covers, cards and packaging.

**Sustainability**



The UK use over 12 million tonnes of paper each year and it takes approximately 25 trees to make one tonne of paper. Trees take in Carbon Dioxide (CO<sup>2</sup>) and produces oxygen but it takes a lot of energy to cut them down and make paper.

An alternative is to recycle paper and this is becoming more common as this uses between 40% to 70% less energy to produce.



## What you need to know:

- Know the primary sources of materials for producing papers & boards
- Be able to identify a range of natural timbers & manufactured boards.
- Understand their properties and the functions they provide and how they are used?

Natural Timbers		Manufactured Boards
Hardwood	Softwood	
		
<p>Hardwoods are usually obtained from <b>deciduous</b> trees, which lose their leaves in autumn.</p> <ul style="list-style-type: none"> <li>❑ usually grow in warmer more humid climates, mainly in South America and Asia</li> <li>❑ grow slowly (80+ years)</li> <li>❑ are more difficult to sustain than softwoods</li> <li>❑ are more expensive than softwoods</li> <li>❑ are strong and hardwearing.</li> </ul>	<p>Softwoods are usually obtained from <b>coniferous</b> trees, which keep their leaves in winter and are also known as evergreens. These grow quickly which makes them sustainable as they are renewable. This also makes them cheaper when compared to hardwoods.</p> <ul style="list-style-type: none"> <li>❑ Usually grow in colder climates and are mainly grown in Scandinavia and Northern Europe</li> <li>❑ Grow thin, needle-like leaves</li> <li>❑ Grow relatively quickly (30 years)</li> <li>❑ Are easier to sustain than hardwood trees</li> <li>❑ Are easy to cut and shape</li> <li>❑ Are usually cheaper than hardwoods</li> </ul>	<p>Manufactured boards are made from the waste sections of felled trees – the parts which are of little use as planks. The wood is reduced to pulp, particles or thin strips and bonded together using special adhesives or resins. Manufactured boards are made as alternative to natural timber.</p> <ul style="list-style-type: none"> <li>❑ Come in sheet form (usually 1.2 x 2.4m)</li> <li>❑ Are extremely stable and of uniform thickness</li> <li>❑ Are less expensive than laminating planks of timber</li> <li>❑ Can be covered with veneers</li> <li>❑ Are available in a variety of thicknesses (3, 6, 9, 12, 15, 18, 22mm)</li> </ul>

## Sustainable Timber



Wood is considered to be sustainable material as trees can be grown to replace those used for timber or fuel. A big issue is in many parts of the world timber is being used faster than trees are being replanted. This causes deforestation which is seen as a key factor to global warming.

To regulate this The Forest Stewardship Council (FSC) are dedicated to ensuring that timber supplies are regulated and sustainably harvested.



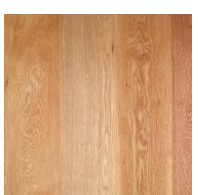

## Types of Hardwoods

	Example	Properties	Uses
Ash		Tough and flexible, wide grained, shock resistant and finishes well	Sports equipment, hand tools and ladders
Beech		Strong, dense close grain but is prone to warping and splitting	Furniture, children's toys, bench tops
Mahogany		Strong and durable, easy to work with finishes well.	High end furniture
Oak		Strong and lightweight	Flooring, furniture and timber framed buildings
Balsa		Strong and durable but very lightweight. If too thin can snap & break.	Model making, floats and rafts

	Example	Properties	Uses
Medium Density Fibreboard (MDF)		This compressed board is rigid and stable and is easy to work with. It has a smooth surface but it is very absorbent.	Flat pack furniture, kitchens and toys
Plywood		This is a laminated board it is stable due to its alternate layering a 90°. It has good water resistance.	Furniture, shelving, skateboards and exterior fencing
Chipboard		This compressed board not as strong as MDF or plywood is prone to chipping	Flooring, low end furniture kitchen units & cupboards

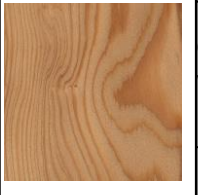
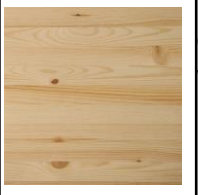
## Types of Softwoods

	Example	Properties	Uses
Larch		Tough and durable, good water resistance and finishes well	Fencing, cladding, decking, furniture
Pine		Lightweight easy to work with but can be knotty	Interior joinery and furniture and window frames.
Spruce		Easy to work with and is lightweight	Furniture, musical instruments and construction

## Finishing Natural Timbers

Timbers can be treated with a number of surface finishes these include Paint, Stain, Wax & Varnish. Applying these finishes can:

- ❑ Seals the wood to protect the surface from heat and water
- ❑ Enhance the grain & surface
- ❑ To colour the surface
- ❑ To give a specific aesthetic appeal.

## Finishing Manufactured Boards

### Veneer

A sharp blade cuts very thin layers wood called veneer. A layer of veneer can be glued onto less expensive manufactured board to produce a more attractive finish and imitate natural timbers but maintain the properties of a manufactured board.

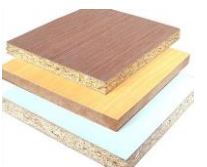

### Lamination

Laminating involves bonding by gluing strips of materials together in layers to create a strong structure. An example of this is wooden beams. If thinner materials are used for lamination the curves can be more complex.





**What you need to know:**

- Know the primary sources of materials for producing polymers
- Be able to recognise and characterise different types of polymers
- Understand the physical working properties for a range of thermosetting and thermoplastics.

Man made (synthetic) plastics have replaced wood and metal in the manufacture of a wide range of products. The 1<sup>st</sup> synthetic plastic was celluloid. It was made from cotton and camphor and used for table tennis balls and film.

Commercial production of plastics really started after the 2nd World War. The raw materials used were either coal or oil. They contain a number of different chemicals which can be separated into parts by a process called **Fractional Distillation**.

Some of the fractions contain chemicals that are small molecules (**Monomers**). The monomers are chemically joined together to make longer molecular 'chains' called **Polymers**

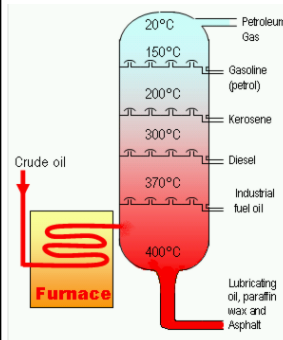

There are many different types of plastic and can be split into four groups :

**THERMOPLASTICS** are made from long chain polymers, joined by weak chemical bonds. When the plastic is softened by heat the bonds break making the plastic 'semi fluid' and able to be shaped. As the plastic cools, new weak bonds form and the shape will be fixed. Because no chemical reaction has taken place this process can be repeated many times, making them recyclable, however excessive heat will permanently damage the chemical structure.

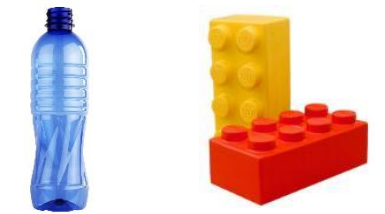

**THERMOSETS** or thermosetting plastics are plastics which are converted into their final form by heat. Once set, they cannot be softened by further heating as they undergo a chemical change. They have strong chemical bonds that hold the long chains together. These make thermosets heat resistant but not recyclable. It is difficult to make products by extrusion or injection moulding as they harden as soon as heated. Manufacturing methods include casting, moulding and laminating.



**ELASTOMERS** are a type of thermoset. The bonds between the chains are 'springy' giving them a rubbery quality. Natural rubber is an example it can be vulcanised to make a rigid (ebonite). Latex is a stretchy elastomer used to make surgical gloves. Lycra is an elastomer used to make stretchy clothing.



Ebonite is an early form of plastic that was used to simulate ebony and is hard and used for bowling balls

**COMPOSITES** are when materials are combined to achieve specific advantages. Examples of composites are Kevlar, GRP (Glass reinforced plastic), Graphite and Carbon Fibre. These are used extensively for sporting uses e.g Bike parts, motor racing car bodies and tennis rackets.



**Plasticisers** are added to make plastic bendy.



**Pigments** are added to change colour.



**Antistatics** are used to reduce static charge



**Antioxidants** to reduce attack by air



**Flame retardants** to reduce burning



**Thermoplastics**

**Acrylonitrile Butadiene Styrene (ABS)** is strong, tough, scratch resistant and resists heat and chemicals. It is injection moulded to make Lego bricks and is used extensively for household appliances like Kettles, vacuum cleaners and housings for cameras and telephones.



**High Density Polythene (HDPE)** is tough and can be blow moulded (bottles for bleach and shampoo) injection moulded (toys and buckets) and extruded (piping)



**Polystyrene (PS)** is used to make vending cups and model kits. It is light, transparent but quite brittle. It is vulcanised to make **High Impact Polystyrene (HIPS)** This is used for Vacuum forming in thin sheets, which are cheap and easy to work with. Expanded **Polystyrene (EPS)** is used as thermal insulation for packaging and food cartons. It is 90% air.



**Low Density Polythene (LDPE)** is Made into thin film (Carrier bags, wiring insulation and squeeze bottles)



**Problems of using plastics**

Plastic products have a long shelf life, however it also means that they are difficult to dispose of

- Because they do not rot or corrode they are difficult to dispose of
- If burnt they produce black choking gasses
- When molten they are sticky and can cause severe burns
- Thermoplastics can be recycled by melting them down and reforming their shape, but usefulness can be become limited with frequent heating
- Plastic production itself can be polluting
- PVC contains many nasty pollutants and it is one of the most difficult plastics to recycle.

**Thermosetting plastics**



**Polyester Resins** which are combined with fibreglass to produce GRP



**Phenol Formaldehyde** is tough and heat resistant often black in colour. (Used for saucepan handles)



**Epoxy Resins** which are mixed with a hardener and left to set. They can be used to make adhesives and flooring.





**What you need to know:**

- Know the primary sources of materials for producing metals and alloys
- Be able to recognise and characterise different types of metals and alloys
- Understand how the physical working properties of a range of metals and alloys affect their performance

Metal bearing rocks are called ORES, these are mined or quarried from the earth's surface. Metals are obtained from raw ores by a process called smelting. Raw ore is mixed with charcoal and other chemicals, and air is blown into a furnace. The molten metal trickles from the bottom of the furnace and this can be cast or extruded into shapes.



Iron Ore

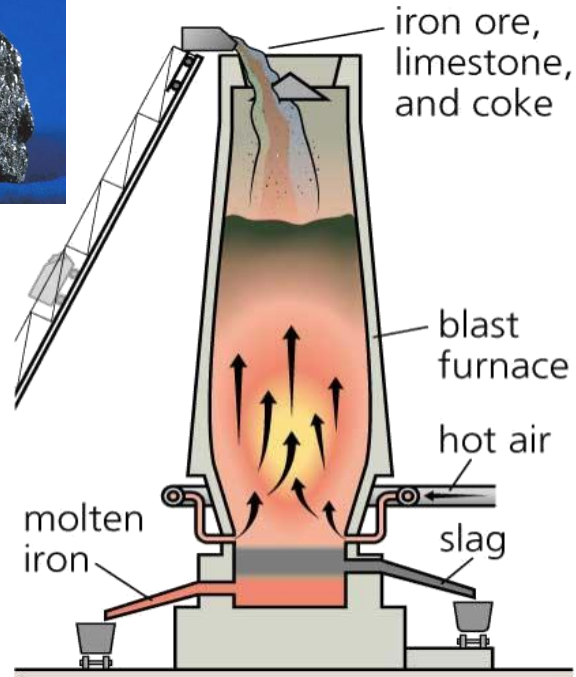

The more the reactive the metal the higher the temperature needed to extract it from its ore. Copper needs 1100°C but iron requires 1500°C. A metal like aluminium cannot be extracted by smelting. It is dissolved in a 'cryolite solution' and electrolysed (electricity is passed through) at a temperature of around 650°C.

A few metals can be mined from the earth as pure metals. These include gold and some small amounts of copper and silver

**Recycling Metals**

Metal ores are either mined or quarried which has an environmental impact. Metal extraction from ore demands a lot of energy, a great deal of which is lost as heat to the surroundings. The high cost has meant that recycling is becoming more and more important. Today the scrap metal industry has a vital role in the provision of metals for the future. Automated disassembly lines for recycling of metal parts for cars are coming ever closer. At present vehicles are collected sorted and shredded, and then materials are collected from them.

It takes 95% less energy to recycle aluminium cans than it does to produce new cans from aluminium ore. It is possible that future cans will be made from recycled material. Stainless steel can be made from as much as 70% of recycled material. Recycled copper can be refined to be as pure as new. Copper and its alloys have a high scrap value as they are relatively easy to recycle.



**SECTIONS – Solids and tubes available**

ROUND TUBE



HEXAGONAL TUBE



SQUARE TUBE



L-SECTION TUBE



**Ferrous Metals:**

**FERROUS METALS** are those which are iron based. They contain Iron and carbon in varying amounts. As iron is extracted from its ore in a furnace it contains a relatively high amount of carbon. This makes the iron hard but brittle this is known as cast iron. It resists compression but may break if dropped, hit or stretched. It is used to make car brake drums, railings and manhole covers. Cast iron has 4% carbon content.



**High Carbon Steel** is often referred to as **Tool steel** contains 0.6 - 1.5% Carbon. It is very hard and is used to make tools such as metalwork files and saw blades.



**Mild Steel** is very tough, can be bent or twisted and can resist strong impacts without breaking. It is easy to weld. Mild steel is used to make washing machines, construction girders, nuts and bolts and nails. It contains between 0.15 – 0.35% carbon.



**Stainless Steel** Contains about 1% carbon. It also contains other metals, mainly **chromium**. There are over 200 different types of Stainless Steel. They contain a minimum of 11% chromium and also contain **nickel**. Manganese is another metal often included. Stainless steel is often used for medical instruments, kitchen surfaces and pots and pans as it resists scratching and biofouling.



**Wrought Iron** is the most pure iron, containing few imperfections. It is difficult to cast although it makes excellent material for forge work because it is tough. It has less than 0.1% carbon. It is used for gates and railings



**Non-Ferrous Metals:**

**NON-FERROUS METALS** do not contain iron. There are many different metals that fall into this group.

**Aluminium** Pure aluminium is malleable and ductile but has a low tensile strength (aluminium foil). To improve strength it is usually alloyed with copper or magnesium. Because it resists corrosion it is used extensively outdoors in satellite dishes and window frames. Aluminium is very light metal and has a density a 1/3 that of copper and steel. It is a good conductor of heat and electricity. Aluminium alloys are used extensively in the aircraft industry and in motor cars. Approx 150,000 million aluminium cans are produced every year.



**Alloys:**

An **ALLOY** is a material of a mixture of metals or a metal and a non metal intermixed. Metal alloys have advantages. The alloy may contain the properties of two or more metals or other elements.

**Brass** is an alloy of copper and Zinc. Copper is malleable, resists corrosion and is a good conductor of electricity. Zinc is hard but brittle. Brass is used in musical instruments, Valves and in electrical plugs and sockets.



Different combinations of tin, lead and other metals are used to create **solder**. The combinations used depend on the desired properties. The most popular combination is 60% tin, 39% lead, and 1% alloys. This combination is strong, has a low melting range, and melts and sets quickly.





**Lead** is a metal that was once in common use for plumbing, roof flashing and car batteries. It has been replaced by copper, plastics and alloys in many cases but is still used in car batteries. Lead is a soft malleable metal. It is also an accumulative poison.





**What you need to know:**

- Know the primary sources of materials for textile fibres & fabrics.
- To be able to identify a range of textile fibres & fabrics.
- Understand their properties and the functions they provide and how they are used?



**Natural fibres can come from plant or animal sources**

	Origins	Example	Properties	Uses
<b>Cotton</b>	Cotton comes from the fine hairs on the seed pod of a cotton plant.		Soft and strong, absorbent, cool to wear and easily washable. Cotton fabrics can be given a brushed finish to increase their thermal properties	Most clothing, especially shirts, underwear and denim can be made from cotton. Also used for towels and bedsheets
<b>Wool</b>	Wool comes from a sheep the coat is known as fleece.		Warm and absorbent, does not crease easily and has low flammability. Has natural resilience to water, but when wet does take a long time to dry. Is difficult to Launder as it can shrink (felt).	Jumpers, coats, suits and accessories worn for warmth. Specialist wools are very soft and expensive. Felt products and carpets
<b>Silk</b>	Silk comes from a cocoon of the silkworm.		Very soft and fine finish, gentle on skin, can feel cool in summer yet warm in winter, drapes well, absorbent, strong when dry (weaker when wet), tricky to wash, can crease easily and is usually expensive	Luxury clothing including nightwear and underwear, soft furnishings, bed sheets, silk paintings and wall hangings

**Synthetic fibres are manufactured from oil based chemicals.**

	Example	Properties	Uses
<b>Polyester</b>		Tough, strong, hard wearing, very versatile, holds colour well, non-absorbent so quick drying, machine washes well. Often blended with other fibres. Easily coloured	Clothing, fleece garments bedsheets, carpets, wadding, rope, threads, backpacks, umbrellas and sportswear
<b>Polyamide (Nylon)</b>		Good strength, hard wearing, non-absorbent, machine washes well, easily and frequently blended	Clothing, ropes and webbings, parachutes and sports material. Used as a tough thread on garments
<b>Elastane (Lycra)</b>		Added to fabric to enhance working properties, particularly to add stretch. Allows freedom of movement, quick drying, holds colour well, machine washable	Sportswear, exercise clothing, swimsuits, hosiery, general clothing, surgical and muscular supports

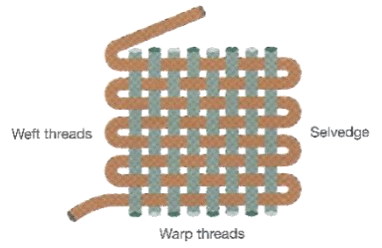
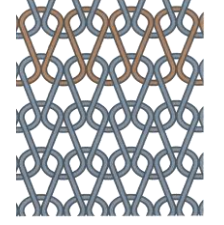
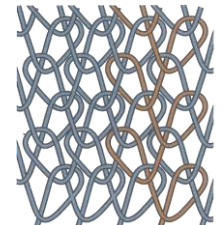
**Types of Fabrics**

Fabric	Example	Properties	Uses
<b>Woven fabric (Plain Weave)</b>	 Woven fabric is manufactured on a loom. Weaving is a process where two yarns the warp and the weft are woven together at right angles to each other. The warp threads run the length of the loom with the weft threads being woven across. The edge that is wrapped around is called the selvedge.	Simple and cheaper to produce than more complicated weaves, stronger than other weave patterns	Used on textiles such as cotton calicos, cheesecloth and gingham, found on table cloths, upholstery and clothing
<b>Knitted (Weft knitted)</b>	 Knitted fabrics are produced by hand or by knitting machines. Knitting is produced horizontally. The loops above and below interlock holding the fabric together.	Warm to wear, different knits have different properties such as stretch and shape retention. Weft knits ladder and unravel more easily than warp	Jumpers, cardigans, sportswear and underwear fabrics, socks, tights and leggings, craft items such as soft toys
<b>Warp Knitted</b>	 Warp knitted fabric is produced on industrial knitting machines. Warp knitting has yarns that interlock vertically along the length of the fabric. Warp knitting is an industrial process only.	Fast production system (industrial process only). The fabric has stretch but can keep its shape and is hard to unravel, less likely to ladder. Complicated manufacturing so it is more expensive than weft knitting.	Sportswear, exercise clothing, swimsuits, hosiery, general clothing, surgical and muscular supports.
<b>Non Woven</b>	 <b>Bonded</b> – Fibre bonded fabric are produced by either adhesives gluing the fibres together. Or heat bonded which melts the fibres so they bond together.  <b>Felted</b> – Felted fabric is produced by needles repeatedly pushing and bonding the fibres together.	<b>Bonded fabrics</b> lack strength, they have no grain so can be cut in any direction and do not fray. <b>Felted fabrics</b> can be formed with moisture and heat; once dry it has no elasticity or drape, and can pull apart easily. Woollen varieties can be expensive	Disposable products such as protective clothing worn for hygiene purposes, tea bags, dish cloths and dusters Hats, handicraft, pads under furniture to prevent scratching, soundproofing and insulation

**Fibres are the starting point from which all fabrics are made.**

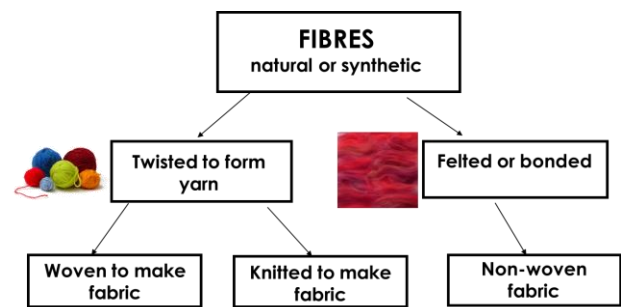

**Blended Fibres**  
This is a combination of two or more fibres spun together into a yarn.

**Mixed Fibres:**  
This is where two or more types of yarn are used when the fabric is woven.

**Reasons for blending and mixing fibres:**

1. Improve the appearance of a fabric in terms of colour or texture.
2. Improve the quality of the fabric e.g. more durable, stronger and longer lasting.
3. Easier to wash and care for the fabric e.g. crease resistance.
4. Improve the feel (handle) of a fabric.
5. Improve the profitability of a fabric so that it is cheaper to produce and is more desirable to consumers.

**Fabric Finishes**

Once a fabric has been produced it often goes through a process to improve its appearance and/or properties. The main fabric finishes are:

- Physical** – machines are used to change the fabric
- Chemical** – chemicals used to change the fabric
- Biological** – bacteria & enzymes used on regenerated fibres
- Coating** – where fabrics are coated on one side

**Why are fabrics finished?**

To enhance: colour, pattern, lustre, texture, softer, firmer, drape, care properties, stain resistance, waterproof, flammability, colour fastness.



**The type of fabric used to make a product depends on the following factors:**

- Aesthetics
- Size of product
- Where and how the product will be used?
- Stability
- Cost
- Size of material
- Weight
- Finish required
- Lifetime of the product
- Desired properties.
- Workability
- Fabric availability



## What you need to know:

- To be able to identify a range of smart & modern materials.
- Understand what they do, their properties and the functions they provide.

### What is a SMART material?

- A 'smart material' can be defined as a material whose physical properties change in response to an input e.g. making them simpler or safer to use.
- A smart material reacts to external stimulus / changes in the environment without human intervention.

Designers and manufacturers are utilising SMART materials in a whole range of mass consumer products which often makes them simpler or safer to use.

SMART Material	Property
Hydrochromic Ink	Changes colour with water
Thermochromic Pigment/ Paint	Changes colour with heat
Photochromic Material/ Dye	Changes colour with light
SMA - Shape Memory Alloy	Changes shape with heat
Phosphorescent Material	Glow in the dark
QTC – Quantum Tunnelling Composite	Soft Electrical Switch
Polymorph	A thermoplastic use for prototyping which can reheated and reused

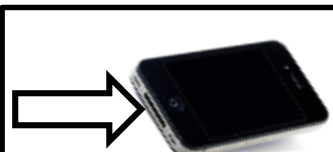

**Hydrochromic paint** is added to the charger socket of the Apple iPhone so apple knows when there has been water damage which voids the warranty.

**Phosphorescent Materials** absorb day light, store it and release it during periods of darkness. This has been extensively used for safety lighting, signage, watch faces and those glow in the dark stars kids have on their bedroom ceilings.



**Thermochromic paints** can be added to any surface like these mugs or a textiles or card based product to react to heat.

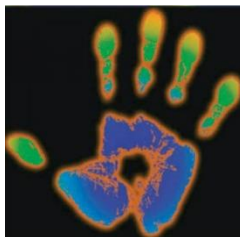



**Polymorph** is a clever thermoplastic which we can use for prototyping and is especially useful when it comes to modelling ergonomic grips. As it is thermoplastic you can reheat and reuse this material as many times as you wish.



**Thermochromic pigments** are added to plastics and react to specific temperatures. One use is enhancing the safety of a babies bowl.

**Compostable plastics** are biodegradable which are compostable & come from renewable raw materials like starch (e.g. corn, potato or tapioca). Polylactic acid (PLA), is made from fermented sugars, found in starch.



**Nanomaterials** are between 1 and 100 nanometres (A nanometre one thousand-millionth of a metre). Nanomaterials include carbon nanotubes, fullerene and quantum dots. Nanomaterials are used in car manufacturing to create cars that are faster, safer and more fuel efficient. They can also be used to produce more efficient insulation and lighting systems. They are also used as thin films or surface coatings, on computer chips.

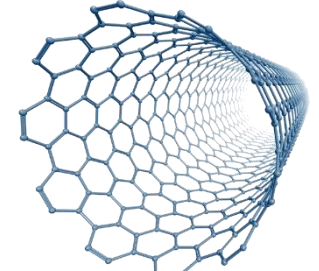

**QTC (Quantum Tunnelling Composite)** is a simple soft switch material that allows an electrical current to flow when compressed. We can use it in children's toys or in many textiles products such as the jacket right >



**Photochromic pigments** react to changes in light. One example is reaction lenses where they darken with sunlight.



**Metal foams** are porous metal structures made from aluminium and titanium. They are strong, lightweight, electrically & thermally conductive and absorb sound well. They are made by injecting gas into the liquid metal but still retain many properties of the original metal including being recyclable.



### What is a MODERN material?

- Modern materials are technical materials which have been manufactured for function.



A good designer will utilise and exploit these materials where appropriate and keep up-to-date with the latest technological developments.

Modern Material	Property
Graphene	Is stronger than steel, flexible, conducts heat and electricity
Titanium	Is strong compared to its weight and is anti-corrosive
Metal foams	Are strong, lightweight, electrically & thermally conductive
Nanomaterials	Nanomaterials are between 1 and 100 nanometres.
Fibre Optics	A hair like strands of pure glass designed to transmit signals
Corn Starch Polymers	Compostable plastics which are biodegradable

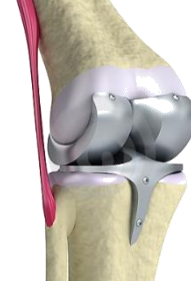

**Shape Memory Alloys** change shape easily but always return to their original shape when they are heated. There are many applications such as dental braces and unbreakable spectacles.

**Titanium** is a very versatile metal. It is usually alloyed with other metals to enhance the properties. Pure titanium does not react to the human body and is used extensively in medical procedures such as artificial joints and dental implants. It is strong compared to its weight and is anti-corrosive.

If it was not for the innovative technology of the **fibre optical** cabling the internet would not be possible. If your parents subscribe to Virgin this is what connects your broadband router or TiVo box to virgin. Without this cable we would not be able to download our music from iTunes or have a Skype conversation with family in Australia.



**Graphene** is a 2D material a honeycomb lattice carbon structure only one atom thick (a million times finer than a human hair) It is 200 times stronger than steel, very flexible, conducts heat and electricity, and is almost transparent. It is impermeable to all known substances. Electronics and energy storage could be revolutionised



## What you need to know:

- To be able to identify a range of composite materials and technical textiles..
- Understand what they do, their properties and the functions they provide.

### What is a Composite material?

- Composite materials are formed when two or more distinctly different materials are combined together to create a new material with improved properties.

Composite Material	Property
Carbon Fibre	Aa very high strength-to-weight ratio, and is extremely rigid, waterproof but very expensive.
Glass reinforced plastic	A very high strength-to-weight ratio, resists corrosion, water resistant and is light weight.



**Carbon fibre** components are manufactured by laying up sheets of carbon fibre (fabric) and joining them together with a thermosetting resin (which makes them solid). We use them extensively in the automotive and aviation industries. It has a very high strength-to-weight ratio, and is extremely rigid, waterproof but very expensive.



**Glass reinforced plastic (fibreglass)** is made from fine glass fibres which are combined with a thermoset plastic resin and is moulded. It has a very high strength-to-weight ratio, resists corrosion, water resistant and is light weight. The fibre glass fibres are soaked in liquid plastic, and then pressed or heated until the material fuses together.

### What are Technical Textiles?

- Technical textiles are manufactured for a specific use e.g. the function. As this is more important than the aesthetic quality.

Modern Material	Property
Kevlar®	Is five times stronger than steel, flexible and lightweight.
Nomex®	Can withstand high temperatures (thermal stability) strong & flexible.
Gore-Tex®	Waterproof & breathable as it prevents sweating.
Microencapsulation	Substances are trapped into fibres and are released through friction.
Conductive fabrics	Electrical signals can to pass through them to power devices.

## Types of Technical Textiles



**Kevlar®** can be a woven or knitted structure and has many applications, ranging from bicycle tyres, racing sails to body armour because of its lightweight, has high tensile strength-to-weight ratio; by this measure it is 5 times stronger than steel. It is also used to make components that need to withstand high impact.



**Nomex®** was developed to withstand high temperatures and reduce combustion when exposed to a naked flame. Nomex has many applications, ranging from protective clothing (fire service & military), racing suits and aerospace applications this is because of its strength, thermal stability, flexibility and resilience.

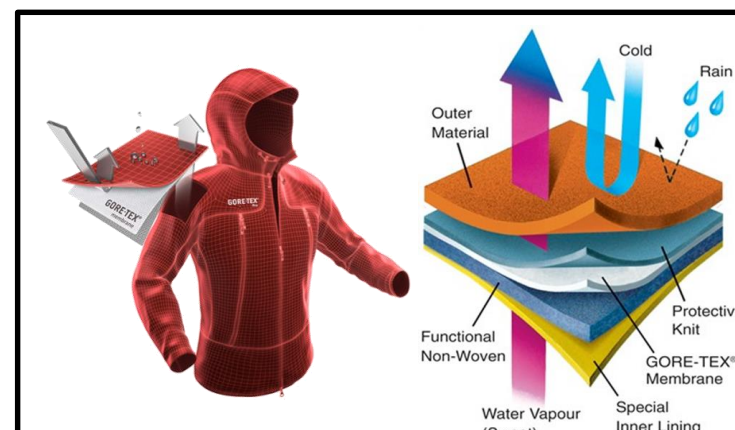

**Gore-Tex®** is a waterproof fabric that is 'breathable' it lets water vapour from perspiration (sweat) pass to the outside, but it stops rain drops from passing to the inside. Clothing or footwear made of Gore-Tex® is very useful to people who work or like outdoor pursuits and sports.



**Microencapsulation** traps liquid or solid substances within the fibres which embedded in to the fabric. When the fabric is rubbed or heated the substances can be released Micro capsules can hold a variety of substances depending on the fabrics intended purpose such as:

- Scents and smells are children's toys fused with a scent of chocolate or scratch and sniff T-shirts.
- Antibacterial solutions are added to fabrics to cuts down on bugs (used in anti-bacterial dressings).
- Insect repellent clothing, chemicals are added to fabrics to prevent mosquito bites.

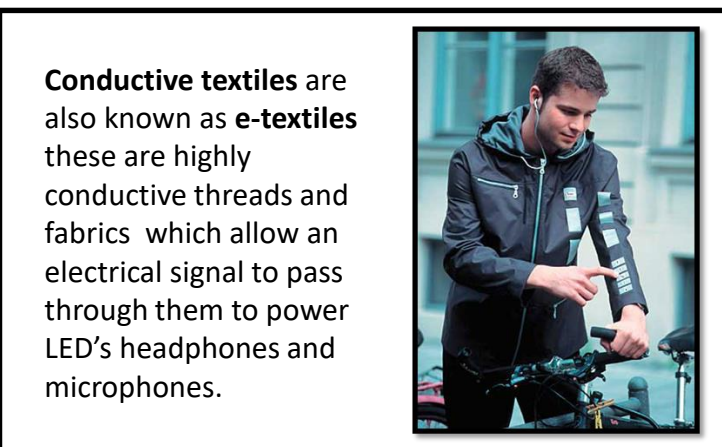

**Conductive textiles** are also known as **e-textiles** these are highly conductive threads and fabrics which allow an electrical signal to pass through them to power LED's headphones and microphones.



**What you need to know:**

- To understand how power is generated from renewable and non-renewable sources and be aware of the arguments for and against.

**Energy generation**

There are many ways to convert energy the two main categories are:

- Fossil fuels (finite)**
- Renewables (non-finite)**

**Turbines & generators**

Most forms of electricity production involve a rotating turbine which turns a generator. Fossil fuels are burned, this heats the water resulting in steam which turns the turbine which is linked to a generator to create electricity.

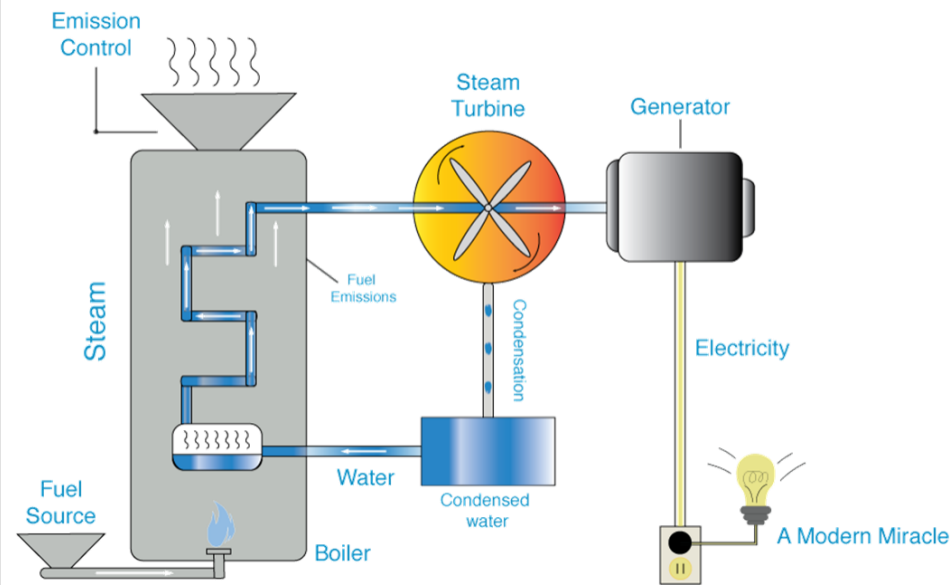

Renewable energy the energy is harnessed from the wind (wind turbines), wave (tidal) or falling water (hydroelectric) is converted into mechanical energy which rotates the turbine. A generator converts the mechanical energy into electricity.

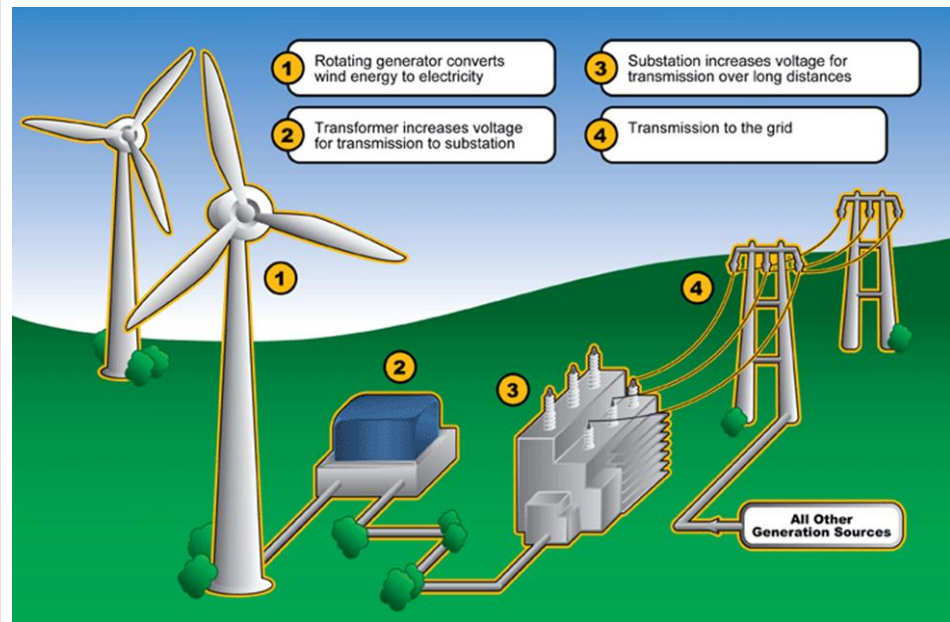

**Non-Renewable Resources**

Traditionally designers have made products from raw materials that come from non-renewable (finite) resources that are in limited supply. Examples of these include oil, ores and minerals. They are natural materials but they will eventually run out.



**WE CAN'T MAKE MORE**



**Renewable Resources**

Renewable means we can create more as long as they are regrown or replaced this includes materials like paper & wood. Energy that comes from the non-finite resources are considered renewable. This includes wind, wave, solar, geothermal, tidal and biomass.



**WE CAN MAKE MORE**



**Solar Energy**

The photovoltaic effect involves the conversion of solar energy into electrical energy. The solar panel capture the sun's rays and converts them into electrical energy.

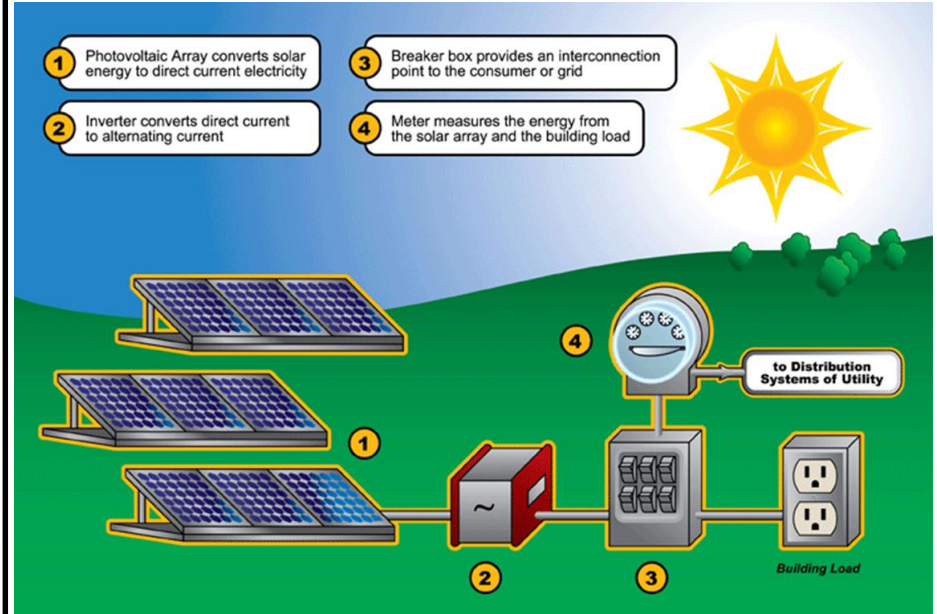

**Nuclear power**

The controversial method of energy, it is considered clean & efficient. The process takes place in the reactor vessel, control rods in and out of the reactors core to regulate the power generated. The reaction generates vast amounts of heat like other methods and generates power to the and generator. The downside to nuclear power is that the waste product produced from the reaction is radioactive and very dangerous to all forms of life. It must be contained and stored correctly so the radiation doesn't leak. This is usually underground and this waste will be radioactive for years.

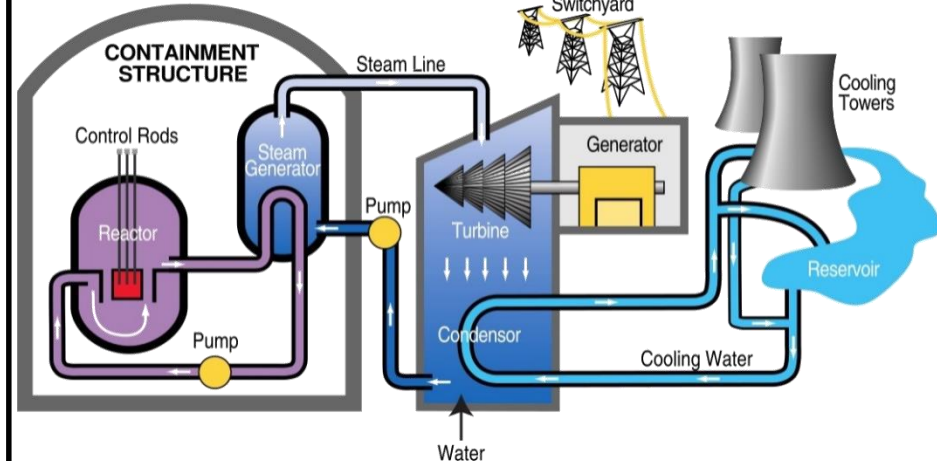

**Fossil Fuels**

Fossil fuels (coal, oil & gas) are considered finite as they can not be replaced. 55% of Britain's electricity is generated from coal and gas.



**Biofuel**

Biofuel is a way of producing energy for transportation & heating. Oli and starch producing crops are grown, harvested and refined into a number of products such as biodiesel. This process is known as biomass energy production. .

